

PX163+

Driver LED C.V.

48 x 700mA

User manual



Table of Contents

1 Description.....	4
2 Safety conditions.....	5
3 Connectors and control elements.....	6
4 Designation of displayed messages.....	7
5 Device programming.....	8
5.1 Button features.....	9
5.2 Group DMX address settings.....	9
5.3 Individual DMX address settings.....	10
5.4 Dimmer DMX address settings.....	10
5.5 Operation mode.....	11
5.6 No DMX signal response.....	13
5.7 Smooth.....	14
5.8 Frequency of PWM signals.....	15
5.9 Minimum level of brightness.....	15
5.10 White balance.....	16
5.11 Screen saving.....	17
5.12 Temperature.....	18
5.13 Default settings.....	19
5.13.1 Memory error.....	20
5.14 Software version.....	20
5.15 Rotation of the display.....	21
5.16 Service mode.....	22
6 DMX signal connection.....	22
7 RDM – available parameters.....	23
8 Programming.....	26
9 Connection scheme.....	27
10 Dimensions.....	28
11 Technical data.....	29

Manufacturer reserves the right to make modifications in order to improve device operation.

PXM Marek Żupnik sp.k.
Podłęże 654
32-003 Podłęże
BDO register number 000005972

tel. +48 12 385 83 06
mail: info@pxm.pl
www.pxm.pl

Rev.1-4
14.11.2019

1 Description

PX163+ is a 48-channel voltage driver designed for the RGB matrix systems, ideally suited for controlling lighting in large areas consisting of multiple modular elements. An example can be here the facade – LED screens or illuminated floors.

It is possible to control all 48 channels through the DMX-512 protocol with use of the built-in DMX signal receiver. The wide range of supply voltage (12 – 24V DC) and the high ampacity of outputs (maximum 0.7A per channel) enable the connection of a lot of LEDs, and consequently the whole surface is equally. By the application of 12 bits for 274Hz and 10 bits for 1kHz of resolution, the brightness control of individual channels is entirely smooth. The implementation of modern technology “*flicker free*”, i.e. a possibility to select frequency 1kHz is the additional advantage. By means of this option, the PX163+ driver can successfully be used in installations made for the needs of the television industry. What is more, the RDM protocol has been implemented in PX163+. In comparison with the previous version the device has been extended with a display unit, an intuitive menu and buttons, which allows convenient configuration.

The device has the function of channels addressing, 18 integrated programs and one scene that can be programmed. The programs can be played in the effective mode or in the case of the disappearance of DMX signal. The driver is produced in a “*common anode*” version, which allows you to connect LEDs with the common plus.

The housing has been adapted for wall mounting, and the screw connectors allow quick and easy installation.

2 Safety conditions

Driver LED C.V. 48 x 700mA is a device powered with safe voltage 12 – 24V DC; however, during its installation and use the following rules must be strictly observed:

1. Installation of equipment, in particular, power connection should be made by a licensed person, in accordance with this manual.
2. The device may only be connected to DC current (stabilized voltage) with current-carrying capacity compatible with technical data.
3. Product is designated only indoor usage. In case of any outdoor usage it should be protected against any weather conditions.
4. All the conductors should be protected against mechanical and thermal damage.
5. In the event of any conductor damaging, it should be replaced with the one of the same technical specification.
6. All repairs can only be made with power off.
7. Do not connect the device to the power supply with visible damage.
8. PX163+ should be strictly protected against contact with water and other liquids.
9. All sudden shocks – particularly dropping – should be avoided.
10. The device cannot be turned on in places with humidity exceeding 90%.

11. The device cannot be used in places with temperature lower than +2°C or higher than +40°C.

3 Connectors and control elements

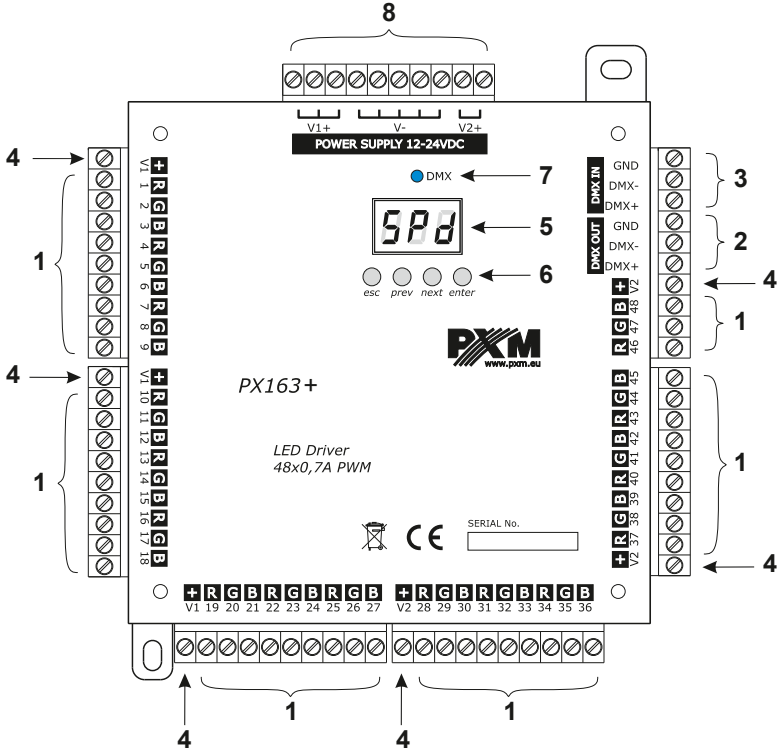

- | | |
|------------------------|-----------------------------|
| 1. Driving outputs(48) | 5. LED display |
| 2. DMX OUT | 6. Control buttons |
| 3. DMX IN | 7. Diode of DMX signal |
| 4. Output power supply | 8. Power supply 12 – 24V DC |

4 Designation of displayed messages

000	DMX address of the device – the basic position in the MENU
800	setting of the parameters for all channels simultaneously
888	setting of the parameters for each channel separately
888	setting of DMX address
088	selection of the driving method
885	selection of the response to the lack of DMX signal
888	driving in the effective mode
888	switching on of all outputs at 100%
888	switching off of all outputs
588	scene
588	setting the scene
888	program no. 17
000	setting of DMX address for the first channel
888	keeping the last value (in the no signal mode)
488	driving in a 48-channel mode
488	driving in a 48-channel mode + dimmer
588	the program playing speed
888	level of smoothness of program steps change
888	setting of brightness of the program
888	frequency of PWM signals
888	low frequency of PWM outputs
888	high frequency of PWM outputs
588	switching on of the screen backlight
888	the memory error message

888	the restore default settings menu in the device
5EH	the function of smoothing of transitions between different values
0ES	minimum level of brightness
6A0	white color balance setting
EBB	white balance mode
0EE	white balance off
3EH	3-channel white balance (for RGB lamps)
4EH	4-channel white balance (for RGBW lamps)
88R	setting red balance
88G	setting green balance
88B	setting blue balance
EBP	preview of current temperature inside the device
688	number of the version of the installed software
8EE	restore default device setting menu
4ES	confirmation of restoring default settings
8E8	message confirming restoration of default settings
800	service mode
808	first channel in the service mode
880	setting the inverted characteristics of a dimmer channel
888	setting the normal characteristics of a dimmer channel

5 Device programming

After you switch on the module, its display shows the program version for a brief moment. To access the main menu, press "**enter**", and the display will show **Adr**. Press "**previous**" or "**next**" to select the appropriate menu and press "**enter**" to confirm your selection.

5.1 Button features

- escape** – goes back to the previous MENU level or discards changes made
- previous** – scrolls to the previous feature on the same MENU level or decreases the parameter's value
- next** – scrolls to the next feature on the same MENU level or increases the parameter's value
- enter** – enters the next MENU level and confirms changes made

5.2 Group DMX address settings

The menu of the PX163+ driver allows for setting the DMX address within a range between 1 and 464 / 508 depending on work mode of device. For example in **48** mode it occupies 48 consecutive DMX addresses. If start address is set to 400, the last channel is occupied by address 448.

To set the DMX address:

1. Set the **Adr** function.
2. Use the "**next**" or "**previous**" buttons to set the selected DMX address.
3. Push the "**enter**" button to confirm choose.

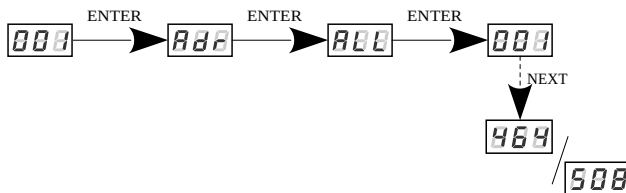

NOTE! Programming the DMX address in this way cancels the previous individual settings of each channel (does not apply to the dimmer address)

5.3 Individual DMX address settings

The PX163+ module has an option that allows for changing individual settings. It enables assigning any DMX address to every output channel.

The simplest example of implementation of this function is to control the lightness of one-color LEDs connected to all outputs. In such case, the same address must be assigned to all channels so that all outputs are controller by one slider on the control panel.

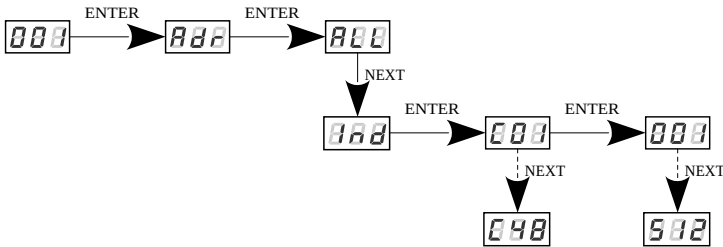

5.4 Dimmer DMX address settings

The user has a possibility to set the dimmer address (default is is 512). In order to do it, the control mode **48d** (48-channel + dimmer) should be selected. If the device works in the **48** or **EFF** (effective) mode, the device display message **888** in the setting field of the dimmer address. After setting the address of the dimmer channel, its characteristic, normal **nor** and inverted **inv**, can be selected.

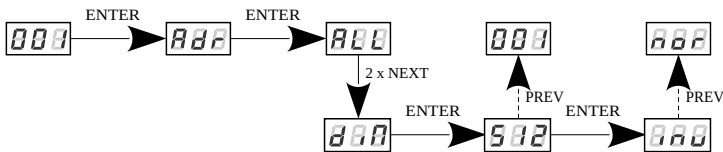

5.5 Operation mode

The PX163+ driver can work in the effective mode (*EFF*), 48-channel (*48*) or 48-channel + dimmer (*48d*).

In order to select the mode, enter *Cbn* function and then select *48* for the 48-channel mode or *48b* for the 48-channel + dimmer or *EFF* for the 4 channel mode (effective) and confirm with the key “*enter*”.

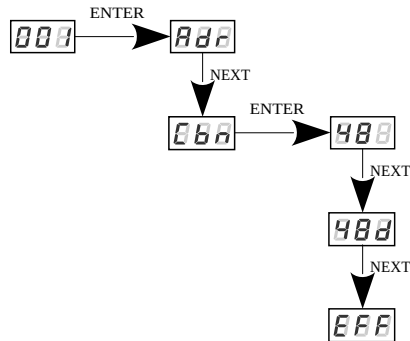

CHANNEL 1 – select the effect

CHANNEL 2 – setting of speed (higher value – faster changes)

CHANNEL 3 – setting of fade (higher value – smoother transition)

CHANNEL 4 – setting of brightness (higher value – stronger light)

sign “**X**” – means the ability to drive the parameter of the selected effect

sign “**-**” – means no ability to drive the parameter of the selected effect

The description of operation of **EFF** – 4 byte (effective) mode

CHANNEL 1 EFFECT	CHANNEL 2 SPEED	CHANNEL 3 FADE	CHANNEL 4 BRIGHTNESS
<0–12> Program 1	X	X	X
<13–25> Program 2	X	X	X
<26–38> Program 3	X	X	X
<39–51> Program 4	X	X	X
<52–64> Program 5	X	X	X
<65–77> Program 6	X	X	X
<78–90> Program 7	X	X	X
<91–103> Program 8	X	X	X
<104–116> Program 9	X	X	X
<117–129> Program 10	X	X	X
<130–142> Program 11	X	X	X
<143–155> Program 12	X	X	X
<156–168> Program 13	X	X	X
<169–181> Program 14	X	X	X
<182–194> Program 15	X	X	X
<195–207> Program 16	X	X	X
<208–220> Program 17	X	X	X
<221–233> Program 18	X	X	X
<234–255> OFF	–	–	–

5.6 No DMX signal response

This function is used both to protect the system against the disappearance of DMX signal and to gain the driving of LEDs without connecting an external driver. After it has been activated, in case of the lack of DMX signal, the module will perform the selected function by itself. Reconnecting of DMX signal will automatically break the performed function, and the module will again send the command with a DMX line.

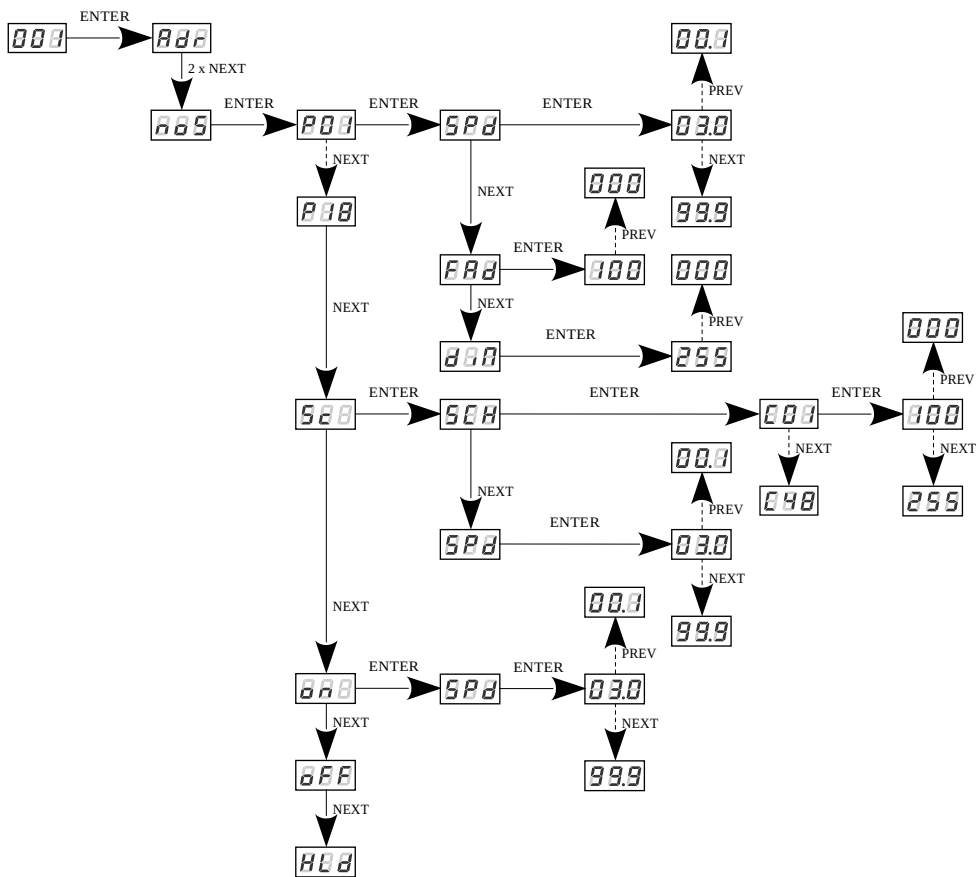

oFF – complete switch-off of outputs

HLd – maintaining the last value on the channels

P01 – P18 – choosing a ready program provided in the device software. For each program it is possible to set the speed (**SPd**) of the effects reproduction in range 0,1 – 99,9s and smoothness of change of steps (**FAd**) in range 0 – 100, where 0 is a step transition, and 100 completely smooth and dimming values (**diM**) in the range 0 – 255.

Sc – programming the value of the scene for individual 48 channels (**C01 – C48**) and also the time of scene entry **SPd** in range 0,1 – 99,9s

on – activating all outputs at 100% (activation time **SPd** in the range 0,1 – 99,9s)

5.7 Smooth

The device has also the smoothing option. Smoothing allows for smooth brightness and color changes. When the function is on, the transition between further DMX values sent to the lamp (e.g. responsible brightness) occurs smoothly without obvious jerks, which prevents the effects of “vibrations” in the lighting systems. The user has the option of disabling smoothing or selecting one of four levels (1 – 4).

Level **1** – lowest smoothing

Level **4** – highest smoothing

OFF – smoothing off

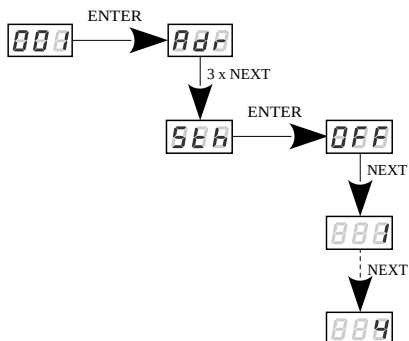

5.8 Frequency of PWM signals

The *Frq* function allows you to set the base frequency to drive LEDs. This function is extremely useful for applications in the television industry. By using “*flicker free*” technology, you can avoid an unpleasant image flicker effect caused by a lack of appropriate synchronization of LED driving signal.

The user has two available frequency: 274Hz (*Lo*) and 1kHz (*Hi*). The value of frequency in the upper range avoids the flicker effect visible in the cameras.

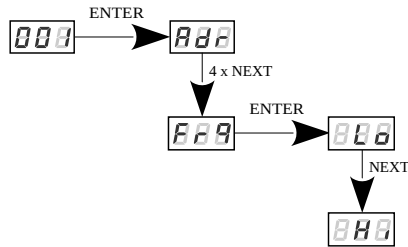

5.9 Minimum level of brightness

The function of setting the minimum level of brightness (*OFS*) has been implemented in the PX163+ device, which can be set in the range from 0 to 100.

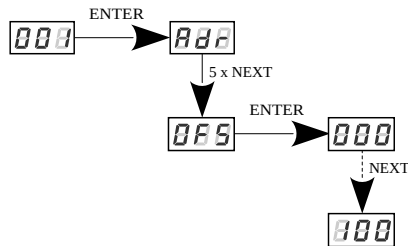

The way it functions is presented in the diagram below:

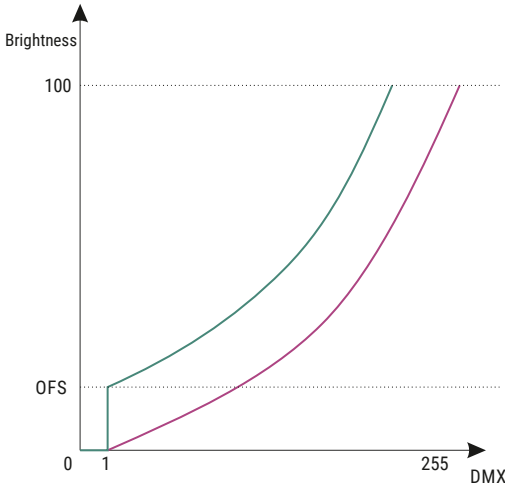

This parameter is useful when the diodes connected to the driver show unstable functioning at the low control levels. In such a case the increase in the value *OFFSET* can result in achieving better dimming effects.

5.10 White balance

There may be problems with reaching white on the LEDs of the RGB / RGBW series. This may be due to use of diodes with different technical parameters. For this reason, the PX163+ module is equipped with a white balance function (*bAL*). This option allows to select the proper color temperature for the full control of all outputs (white color).

__r – setting the value of the red balance

__G – setting the value of the green balance

__b – setting the value of the blue balance

Fun – selection of the white balance mode: **3cH** for the 3-channel RGB mode, **4cH** for the 4-channel RGBW mode and **OFF** when the white balance is not activated

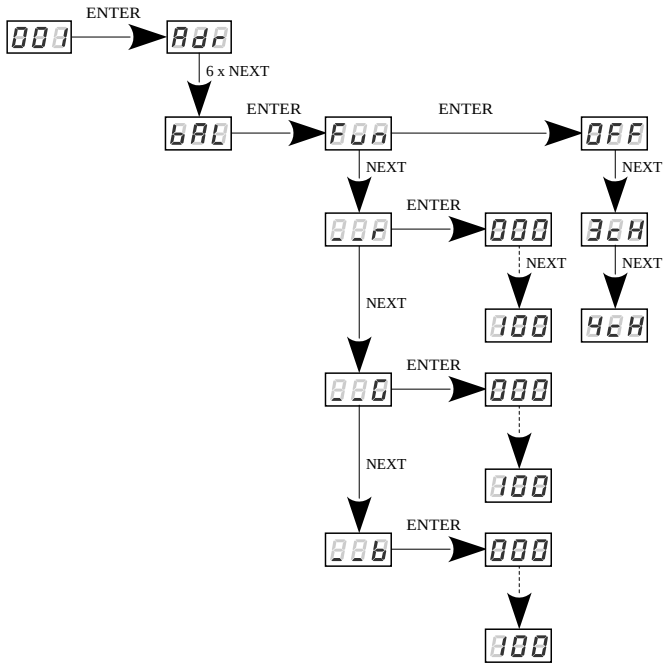

When the **3cH** mode is chosen, all three exit channels are calibrated, in the **4cH** mode only the first 3 channels of each four channels are calibrated. The white channel (4 – **White**) is unchanged.

5.11 Screen saving

The device is equipped with a feature that allows for turning off the backlight. The **ScR** option activated turns off the display after 60s of inactivity (do not use keys). The device continues its operation without interfering with other parameters. Press any key to restore the backlight.

On – screen saver activation

oFF – screen saver deactivation

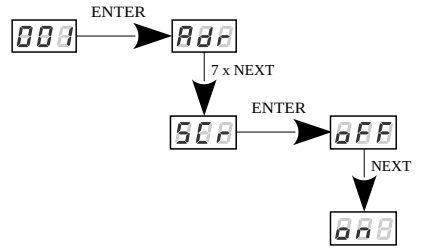

5.12 Temperature

The PX163+ was equipped with the possibility to check the temperature inside the device. If the temperature exceeds 70°C, there is a linear limitation of the device power until the exits will be switched off completely when the temperature reaches 90°C. Additionally, the blinking message *Hot* in the main menu will inform about the increased temperature.

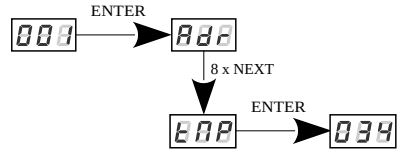
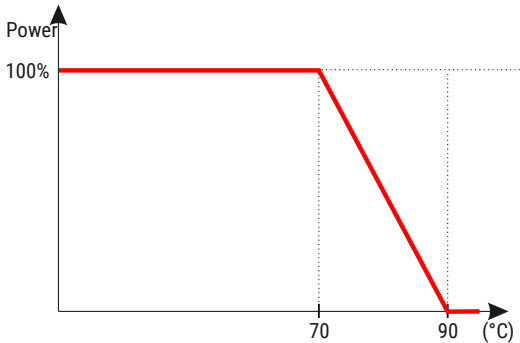

5.13 Default settings

The device was equipped with the possibility to restore the default values and they can be restored in two ways:

- using the command **dEF** (situated in the menu tree)

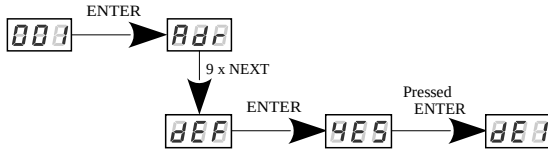

- while turning the device on (using the key “*previous*”)

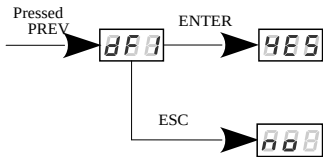

In order to make use of this option, disconnect the PX163+ from the mains supply.

Before reconnecting it to the mains supply, the

key “*previous*” should be pressed and held. Then, after switching on the message **dFI** will appear on the screen of the device (while turning the power supply on to the moment of displaying the message **dFI** the key “*previous*” must be held down). When the **dFI** message is displayed, selecting the “*enter*” button will restore the factory settings, while pressing “*esc*” will return to normal operation of the device without restoring the settings.

The default settings in the PX163+ are the following:

- DMX address: **001**
- operational mode: **48**
- no signal: **oFF**
- smooth: Level **1**
- frequency: **274Hz (Lo)**
- **SCr** option: **oFF**
- white balance: **OFF**

5.13.1 *Memory error*

The device is equipped with a built-in memory work control function. If there are problems with the memory operation on the PX163+ display, the **Err** message appears – memory error.

In this situation, select the “**enter**” key. The device will reload the default configuration and upload it to the memory. If after this operation, the **Err** message remains on the screen, the memory is permanently damaged and the unit must be sent to the service point.

5.14 Software version

It is possible to check the version of the installed software in the PX163+ driver. The **Fir** function allows it.

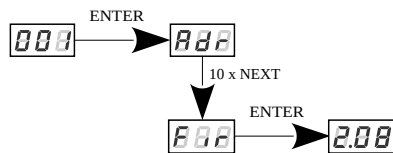

5.15 Rotation of the display

If necessary, you can rotate the display without rotating whole device. Just hold two middle buttons (“*previous*” and “*next*”) at the same time for approximately ~3s.

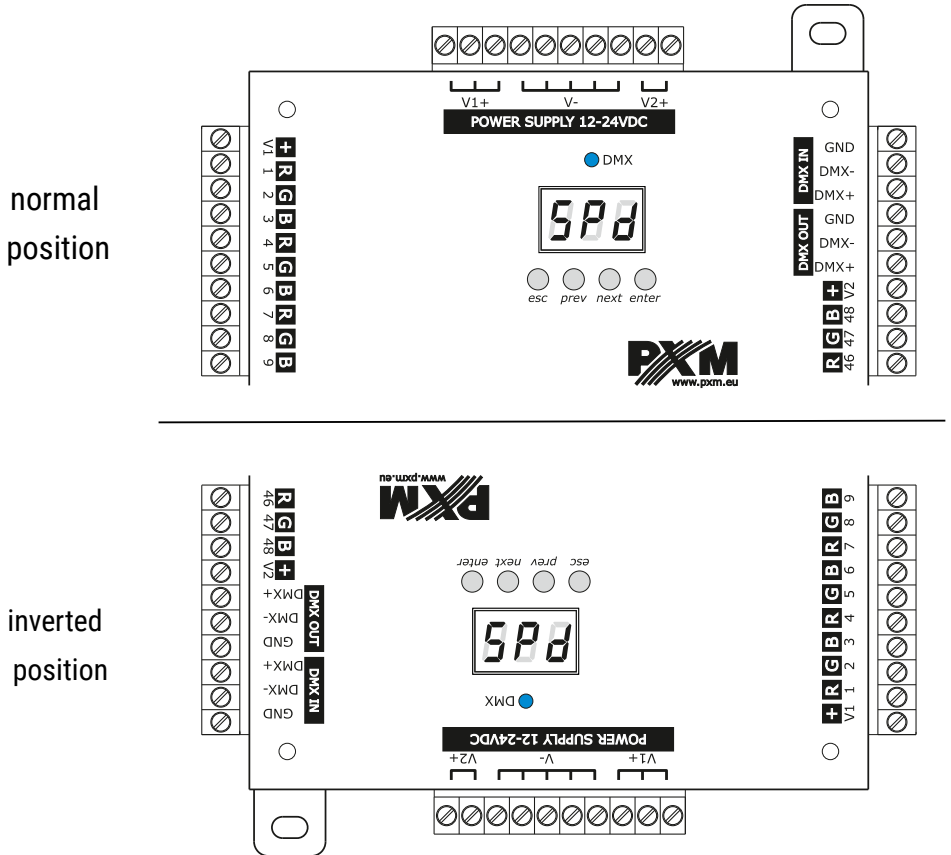

NOTE! The keys on the reverse of the display are set in the same way as the normal position, keys are reversed.

In order to restore the standard setting, hold the middle buttons for approximately ~3s.

5.16 Service mode

The service mode allows to turn the chosen channel on for 100% quickly.

In order to switch in on, go to the initial menu and simultaneously press the keys “*escape*” and “*previous*” longer. The message **000** will appear in the screen, which means that none of the channels is controlled in 100%. Next, enter the selected channel (with the keys “*previous*” or “*next*”). Next channels will be switched on for 100%. In order to output the service mode, press the keys “*escape*” and “*previous*”.

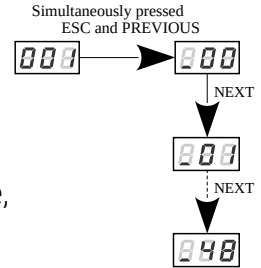

6 DMX signal connection

PX163+ have to be connected to DMX line in serial mode, with no branches on DMX control cable. That means that DMX line, from the signal source, must be connected to **DMX IN** pins of PX163+ and later, directly from **DMX OUT** pins to the next device in DMX chain.

If the PX163+ is the last DMX chain receiver there should be terminator (resistor 120 Ohm) mounted between “**DMX+**” and “**DMX-**” pins of **DMX OUT** section.

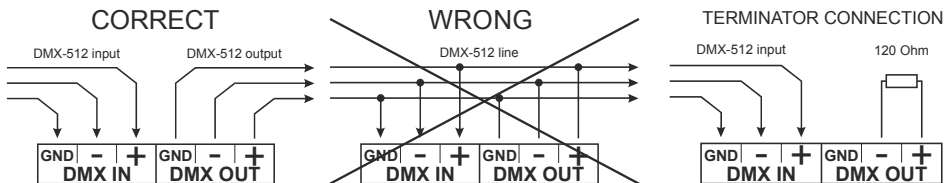

7 RDM – available parameters

PX163+ supports the DMX–RDM protocol. DMX protocol allows only for a one-way data transmission, while its extension the RDM protocol can transmit information in two directions. This makes possible to simultaneously send and receive information, and hence the possibility of monitoring activities of the compatible devices. Thanks to RDM some available settings of compatible devices may be programmed using this protocol.

List of RDM parameters supported by the PX163+:

Parameter name	PiD	Description
SUPPORTED_PARAMETERS	0x0050	all supported parameters
PARAMETER_DESCRIPTION	0x0051	description of additional parameters
DEVICE_INFO	0x0060	information concerning the device
SOFTWARE_VERSION_LABEL	0x00C0	firmware version of the device
DMX_START_ADDRESS *	0x00F0	DMX starting address of the device; Range 1 – 464 / 508
IDENTIFY_DEVICE *	0x1000	device identification; Two states are possible: identification is off (0x00 value) and identification is on (0x01 value)
STATUS_MESSAGES	0x0030	information about device status
DEVICE_MODEL_DESCRIPTION	0x0080	device description, e.g. name
MANUFACTURER_LABEL	0x0081	manufacturer description, e.g. name

Parameter name	PiD	Description
DEVICE_LABEL *	0x0082	additional device description; It is possible to enter an additional device description using up to 32 ASCII characters.
DMX_PERSONALITY	0x00E0	DMX operational mode
DMX_PERSONALITY_DESCRIPTION	0x00E1	description of individual operational modes
SMOOTH_OFF 1 2 3 4 *	0x801A	choice of the option for the Smooth function
NOS_P1-18 SC-19 ON-20 OFF-21 HLD-22 *	0x801C	choice of work mode for No DMX signal
INVERT_DIMMER_VALUE_ON OFF	0x804F	function inverting the characteristics of the dimmer channel
BALANCE_RED *	0x8011	value of control level of red channel balance
BALANCE_GREEN *	0x8012	value of control level of green channel balance
BALANCE_BLUE *	0x8013	value of control level of blue channel balance
SCREENSAVER_OFF ON *	0x8024	settings of screensaver
PROGRAM_SPEED *	0x8025	program playback speed settings (playing next steps of program)
PROGRAM_FADE *	0x8026	settings of smooth transition between following steps of a program
BALANCE_OFF RGB RGBW*	0x8027	to activate or deactivate the balance of output channels
PWM_FREQUENCY_LO HI *	0x8028	frequency of refreshing LED diodes

Parameter name	PiD	Description
SERIAL_NUMBER	0x8030	device serial number
PROGRAM_DIMMER *	0x8032	setting the dimming value
DISPLAY_FLIP_OFF ON *	0x8038	turning the display on the segment display of the device
PWM_FREQ_OFFSET *	0x8055	minimum level of brightness
DIMMER_ADDRESS *	0x8061	DMX address of the dimmer

* – editable parameters

9 Connection scheme

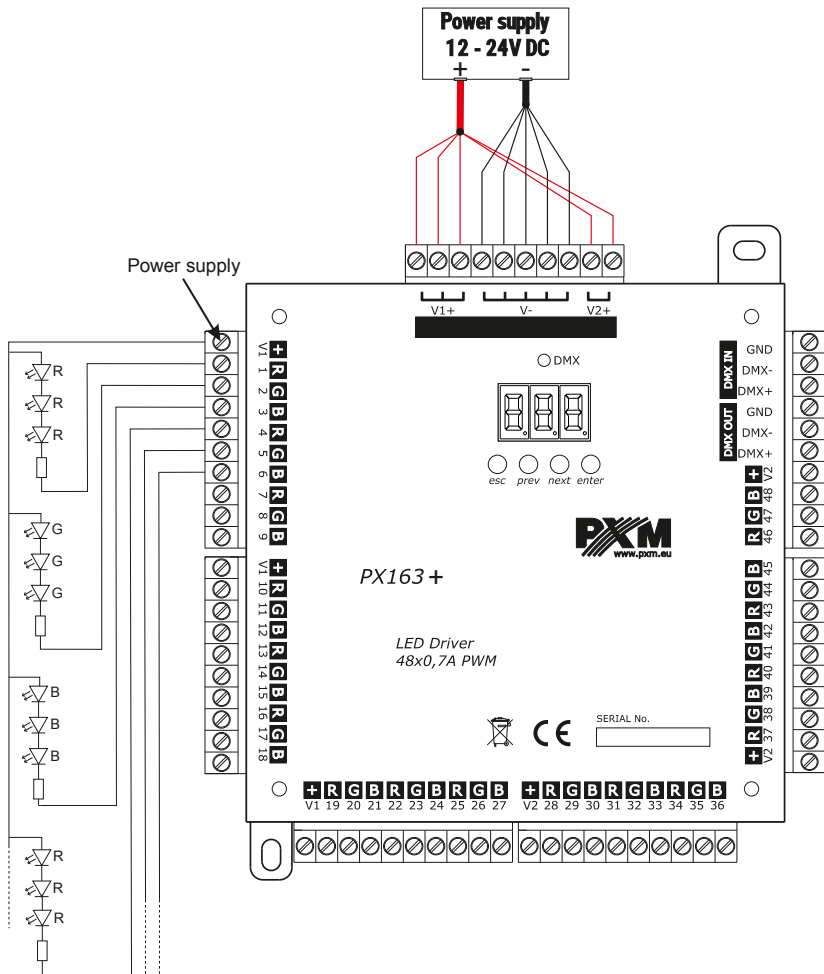

The receivers are connected to control outputs and power supply as shown in the figure below. To each line you can connect only determined number of light sources, depending on the wattage and max load for each line i.e. 700mA. Therefore, after connecting all the receivers you should sum up all the lines and choose adequate power supply.

10 Dimensions

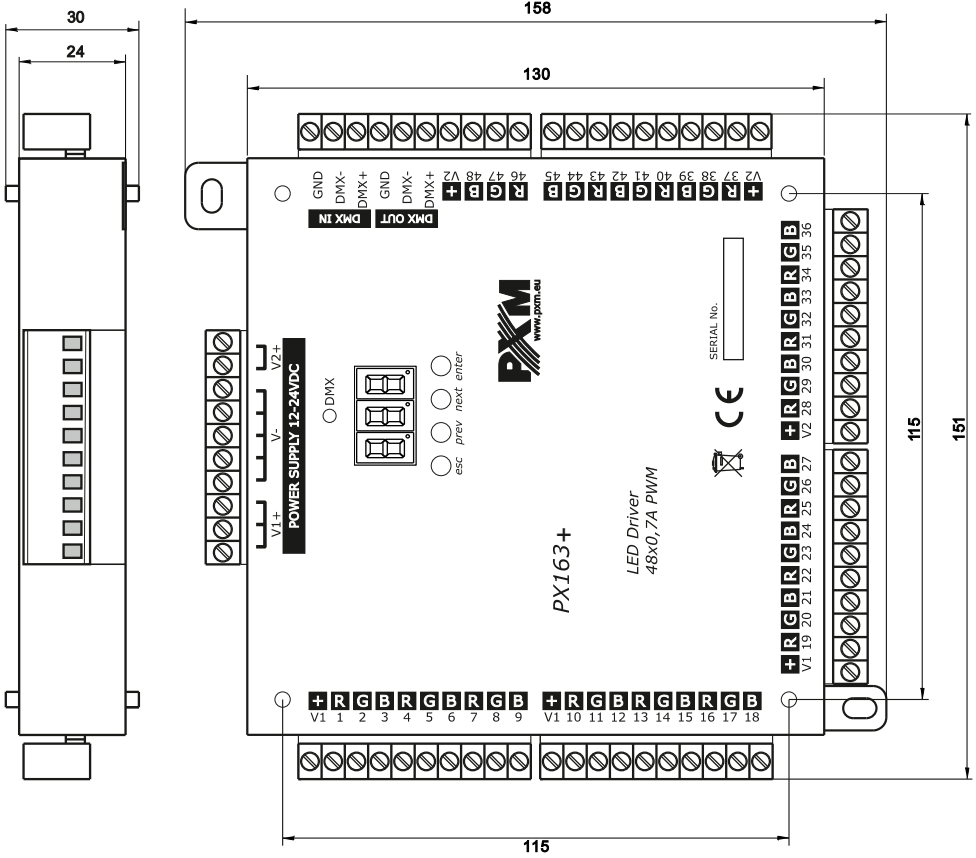

11 Technical data

type	PX163+
power supply	12 – 24V DC
DMX channels	512
output channels number	48
current consumption	max. 34A
control accuracy	12 bits for 274Hz / 10 bits for 1kHz of resolution
outputs load capacity	max. 0,7A / channel
output sockets	terminal blocks
weight	0.6kg
dimensions	width: 151mm height: 158mm depth: 30mm

DECLARATION OF CONFORMITY

PXM Marek Żupnik spółka komandytowa
Podłęże 654, 32-003 Podłęże

we declare that our product:

Product name: Driver LED C.V. 48 x 700mA

Product code: PX163+

Meets the requirements of the following standards, as well as harmonised standards:

PN-EN IEC 63000:2019-01	EN IEC 63000:2018
PN-EN 61000-4-2:2011	EN 61000-4-2:2009
PN-EN IEC 61000-6-1:2019-03	EN IEC 61000-6-1:2019
PN-EN 61000-6-3:2008	EN 61000-6-3:2007

And meets the essential requirements of the following directives:

2011/65/UE **DIRECTIVE OF THE EUROPEAN PARLIAMENT AND OF THE COUNCIL** of 8 June 2011 on the restriction of the use of certain hazardous substances in electrical and electronic equipment Text with EEA relevance.

2014/30/UE **DIRECTIVE OF THE EUROPEAN PARLIAMENT AND OF THE COUNCIL** of 26 February 2014 on the harmonisation of the laws of the Member States relating to electromagnetic compatibility (recast) Text with EEA relevance.

Marek Żupnik spółka komandytowa
32-003 Podłęże, Podłęże 654
NIP 677-002-54-53



mgr inż. Marek Żupnik.